



КАТАЛОГ

Декоративных узоров для вентиляционных решеток



- Проектирование и разработка
- Изготовление на собственном производстве
- Доставка в любую точку РФ и стран СНГ

serviceind.ru

тел: +7(495)411-46-90

s.ind2009@yandex.ru

г. Москва





КАТАЛОГ модульных и геометрических орнаментов

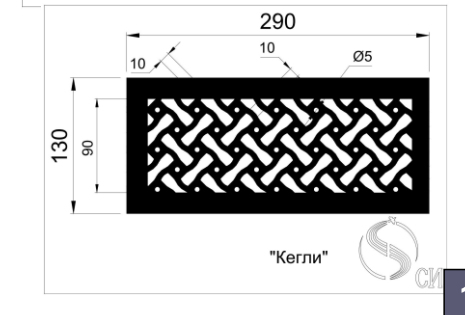
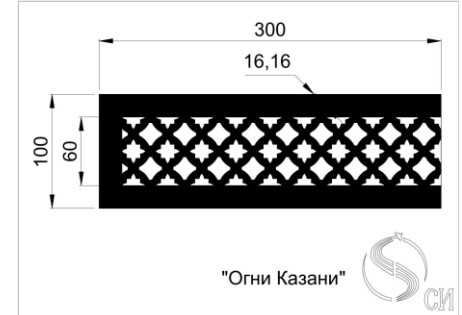
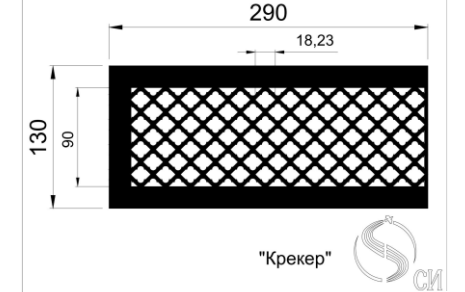
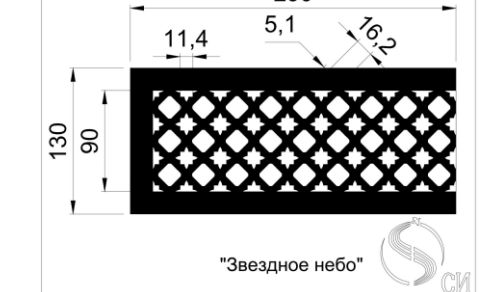
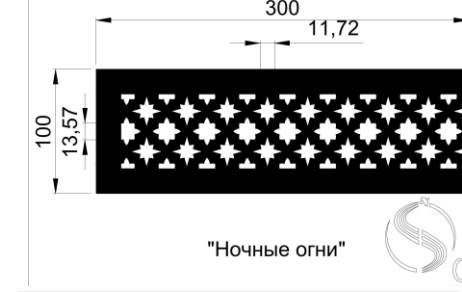
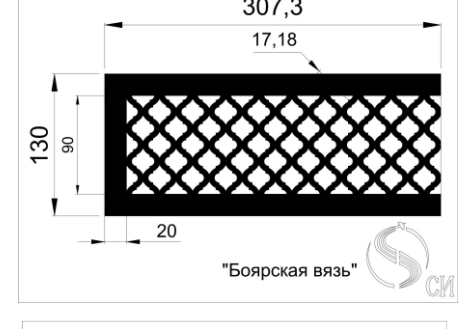
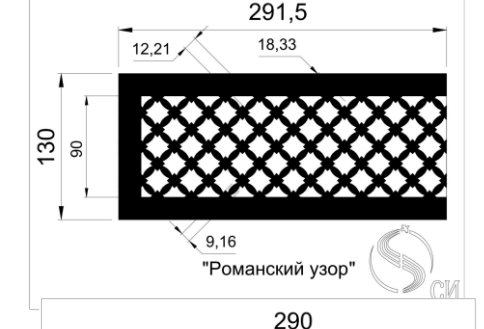
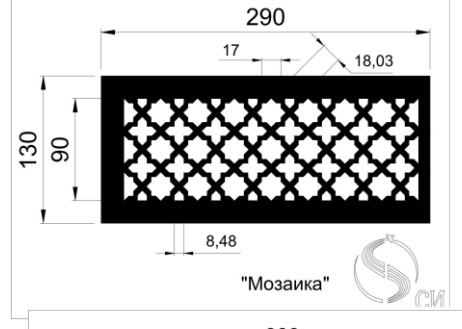
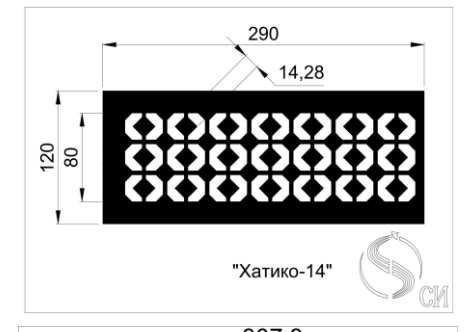
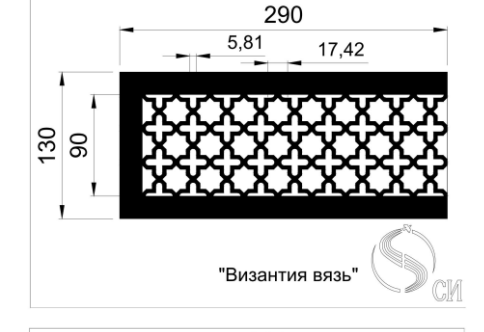
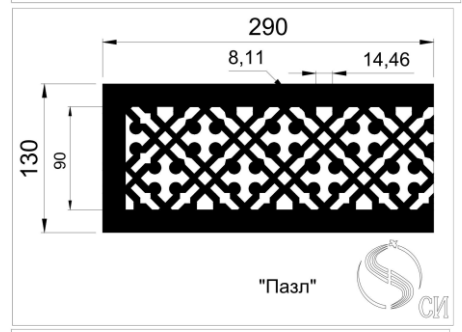
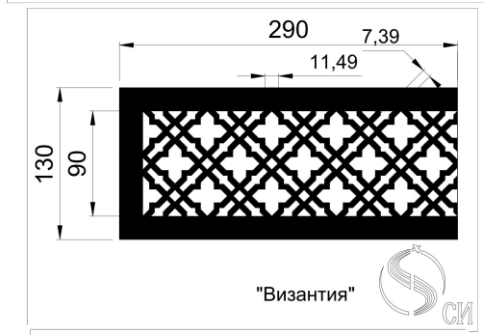
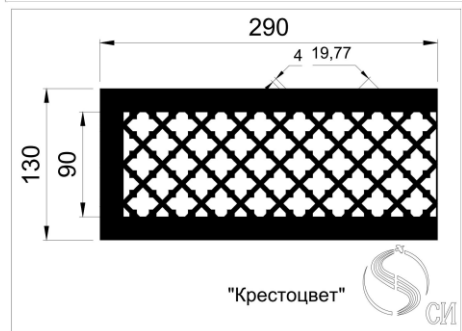
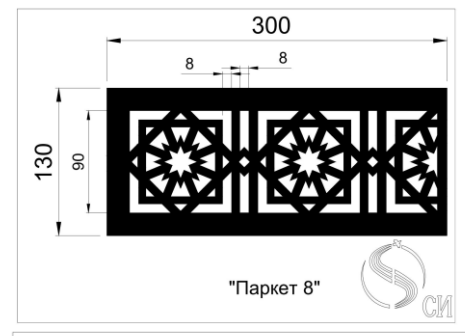
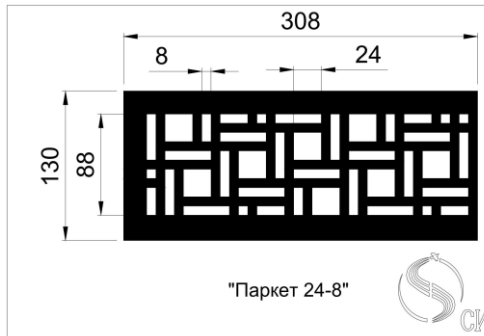
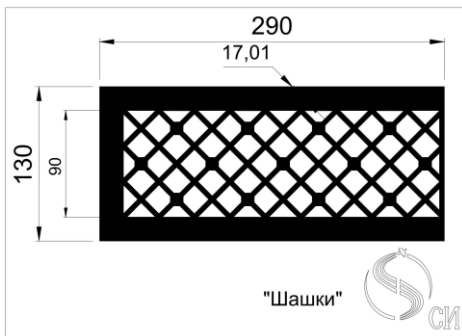



КАТАЛОГ художественных орнаментов

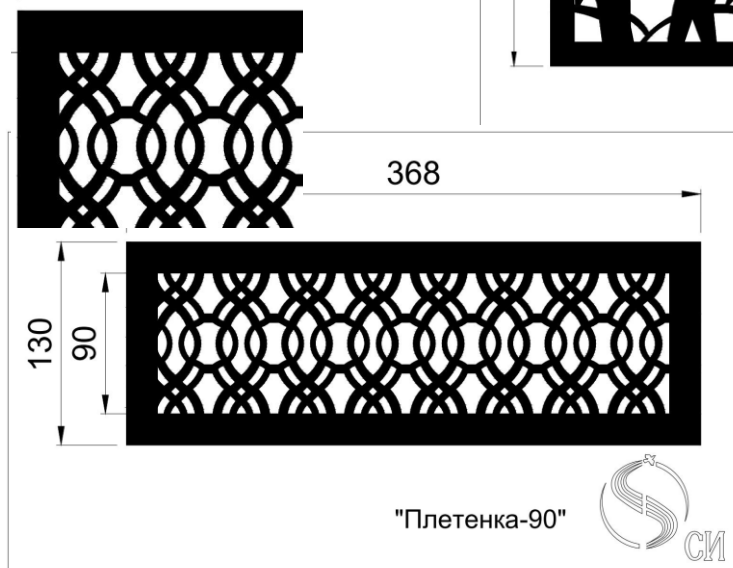
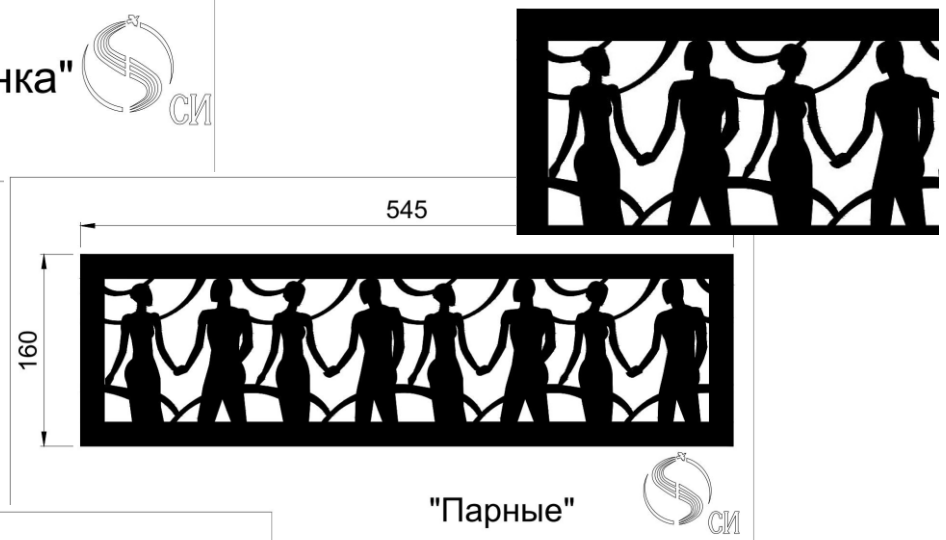
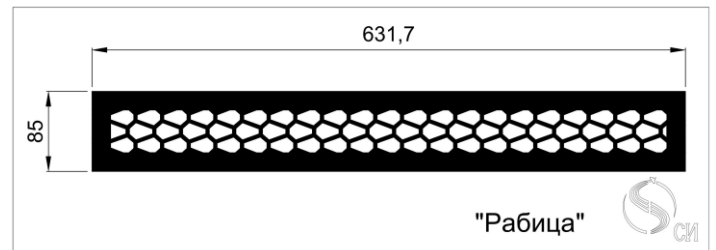
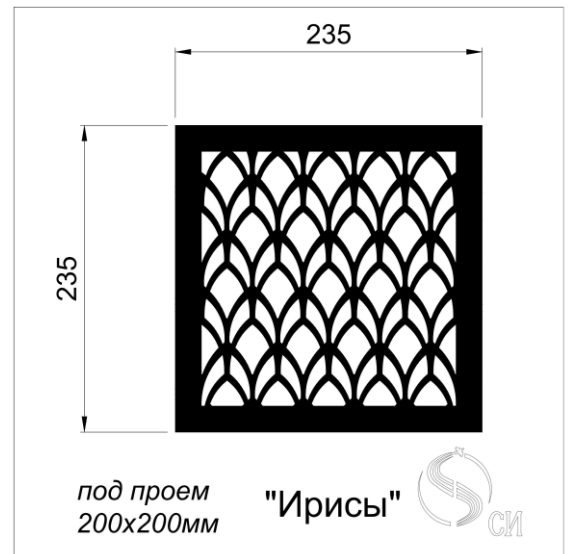
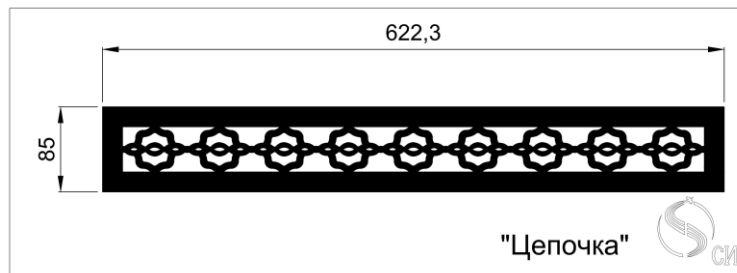
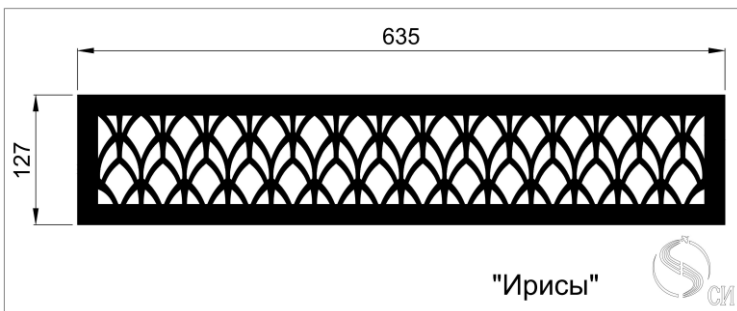

Вентиляционные решетки -Деко
лазерная резка
материал: нерж сталь -шлифовка
ч /сталь, окраска по Рал
врезная; накладная



КАТАЛОГ художественных орнаментов

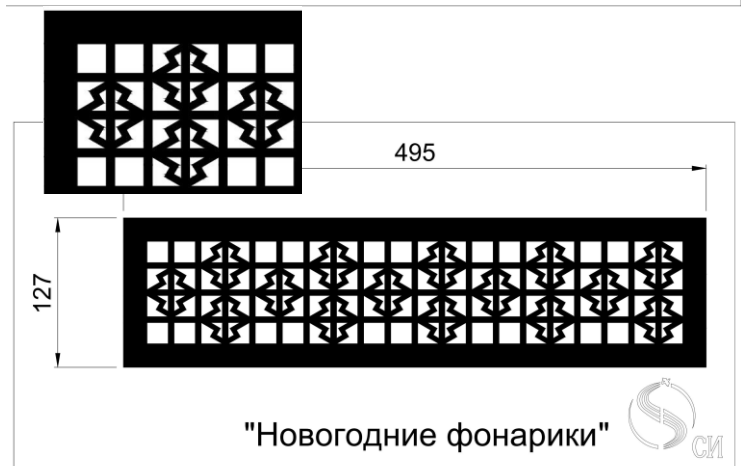
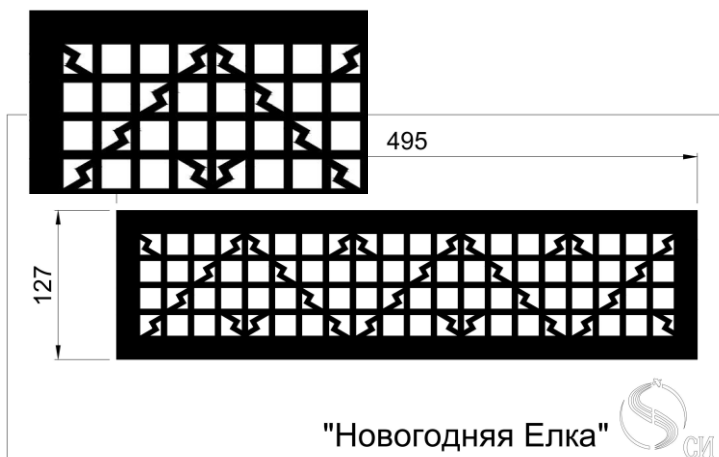
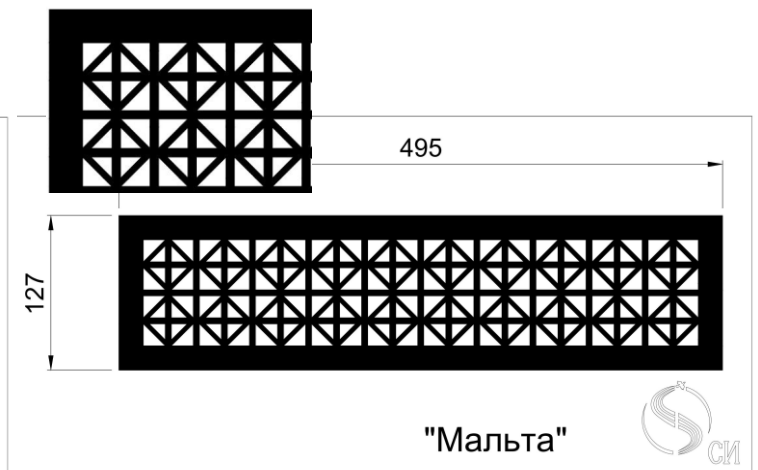
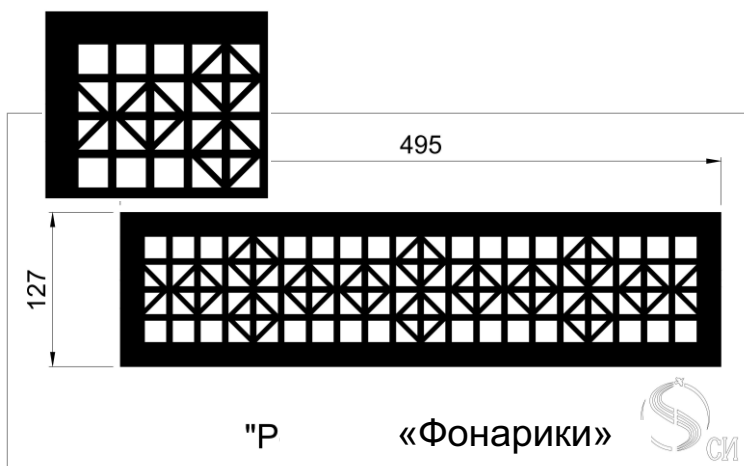
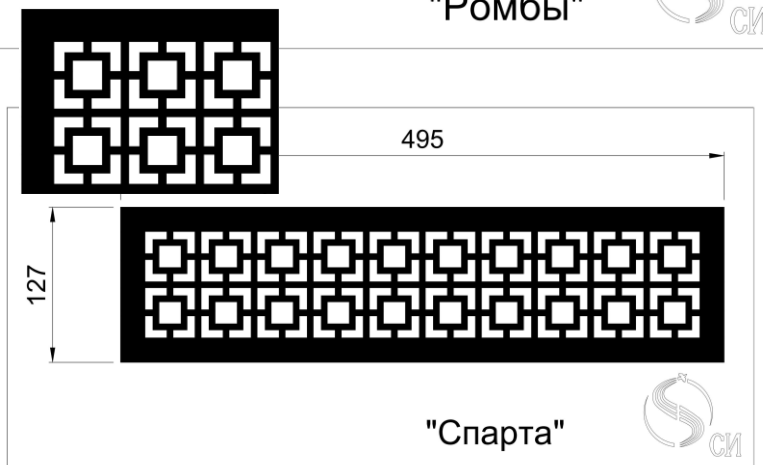
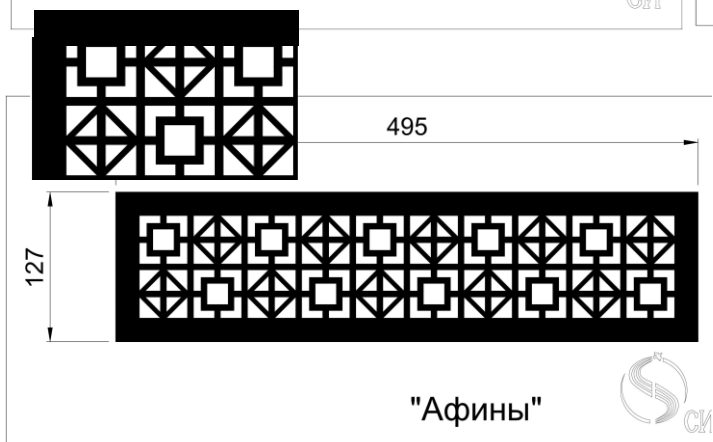
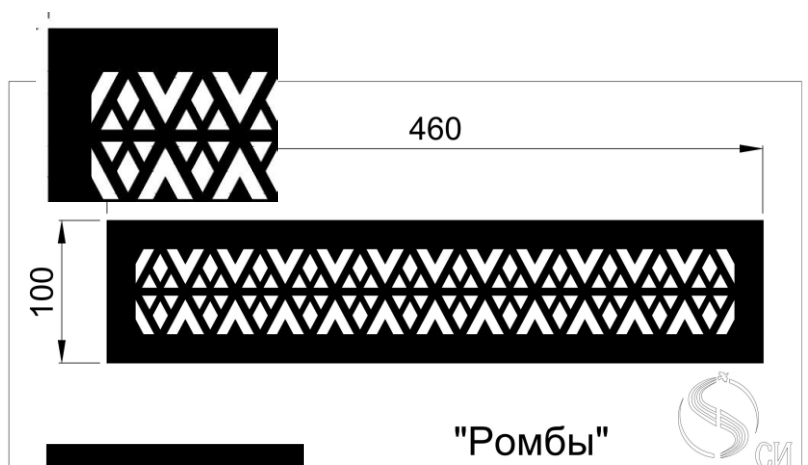
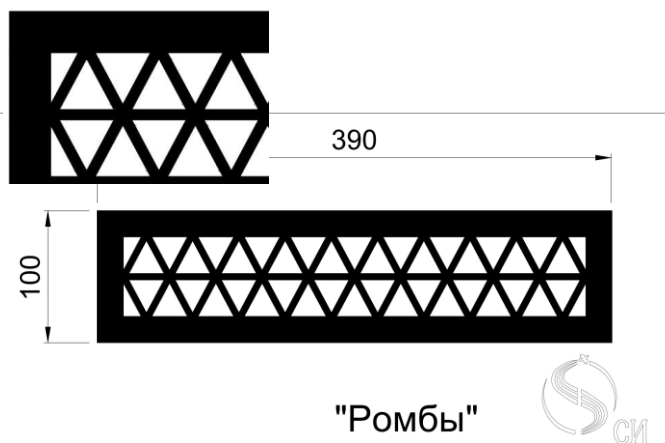



КАТАЛОГ художественных орнаментов «Дзен»

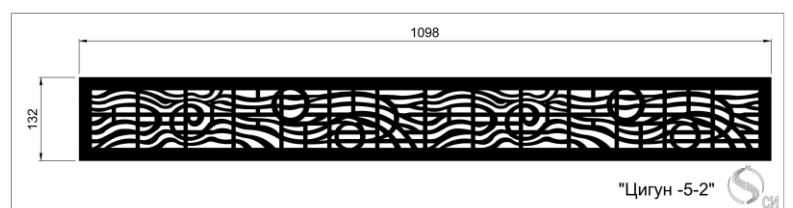
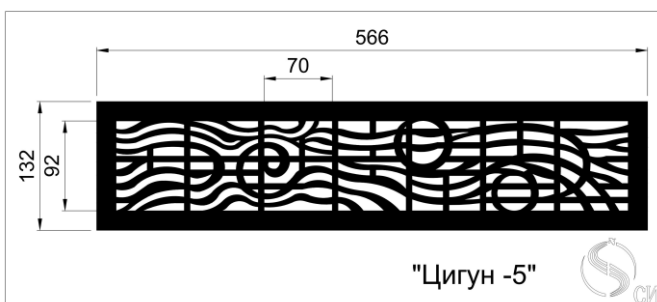
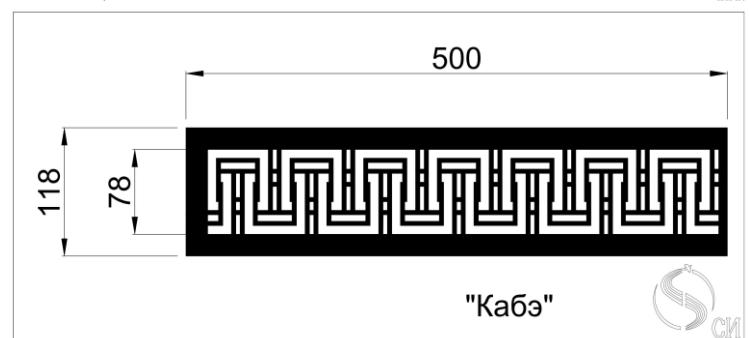
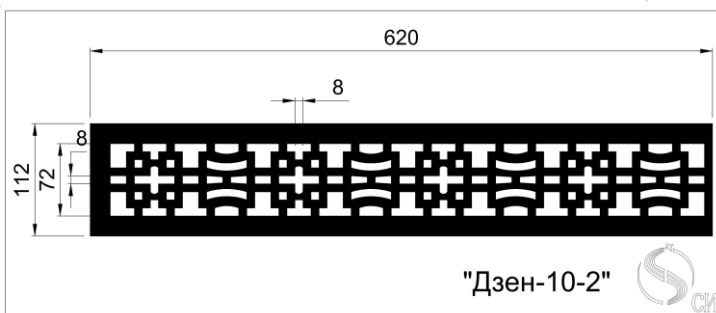
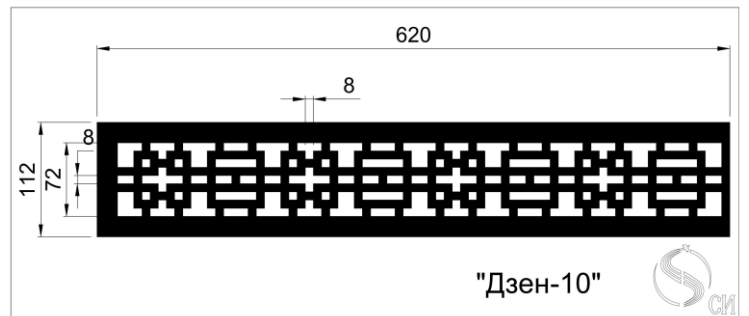
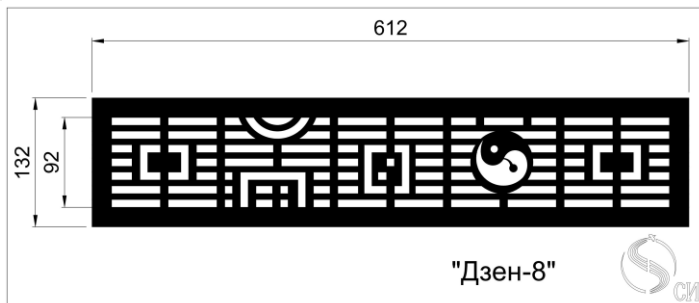
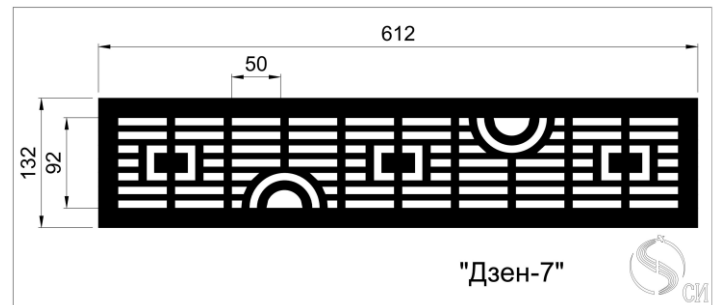
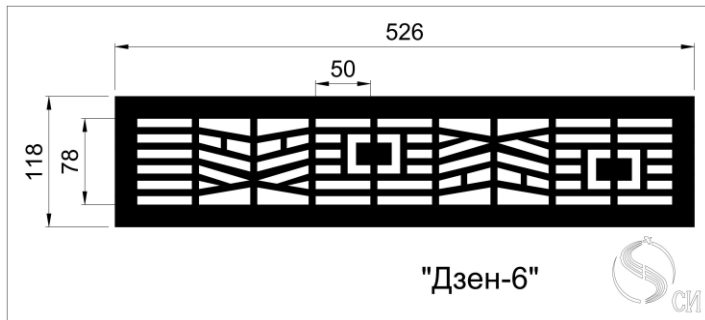
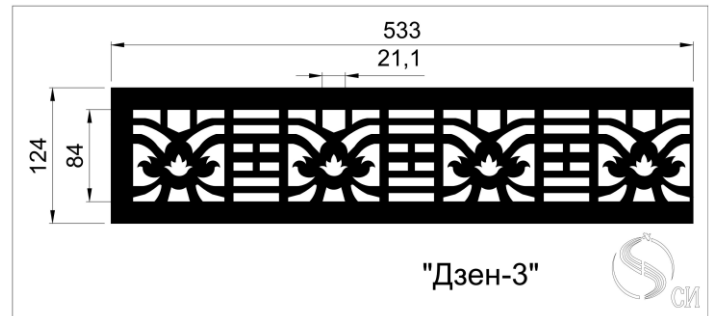
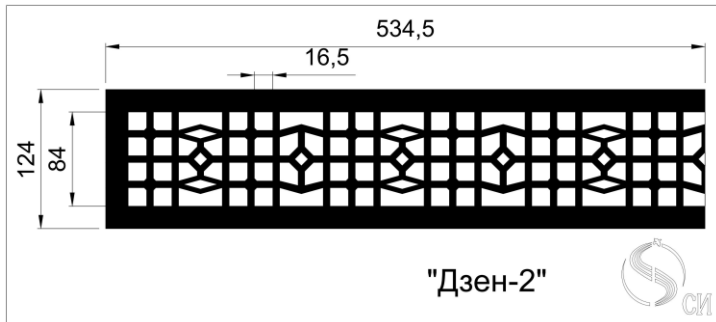



КАТАЛОГ модульных и геометрических орнаментов

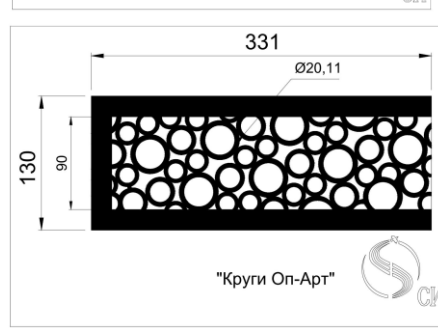
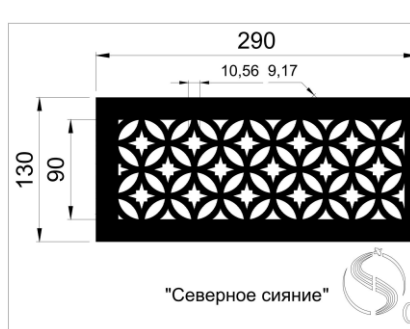
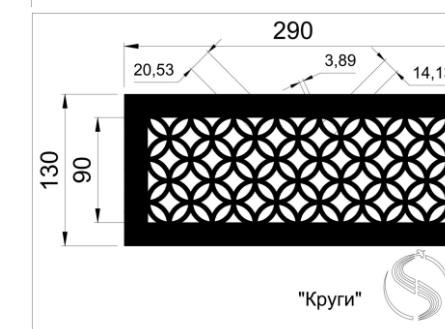
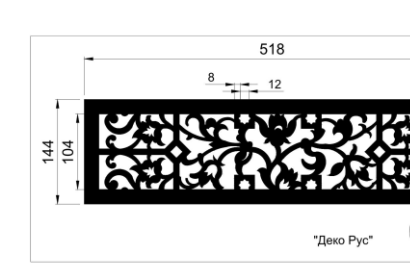
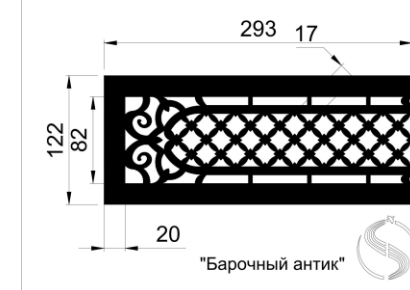
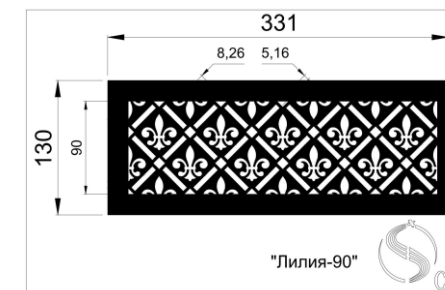
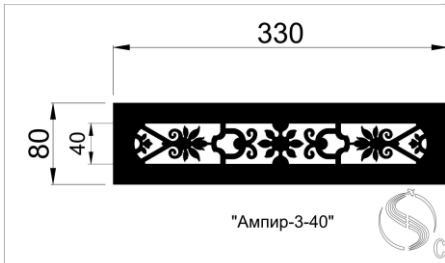
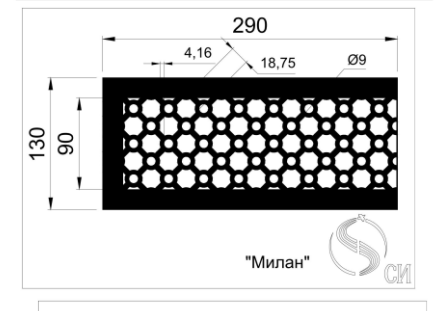
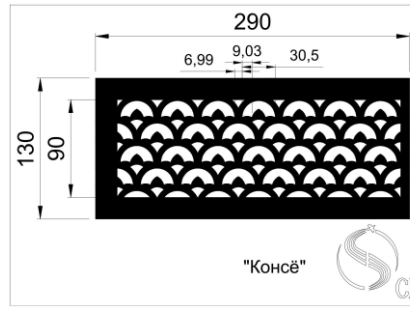
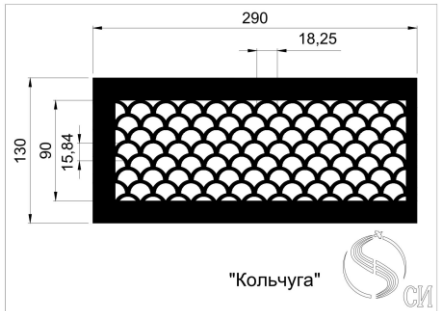
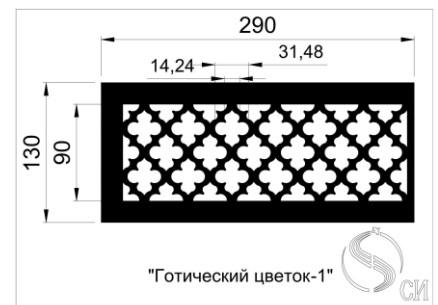
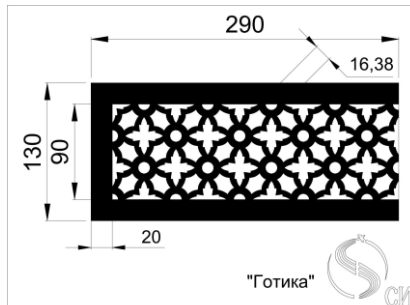
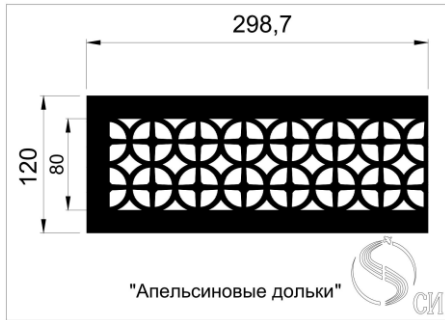



КАТАЛОГ модульных и декоративных орнаментов

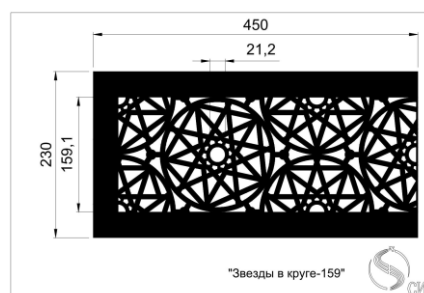
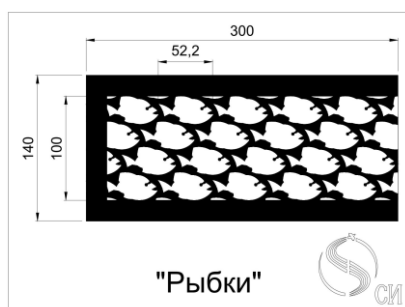
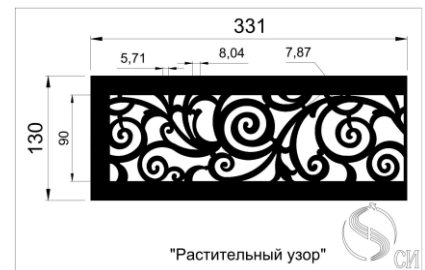
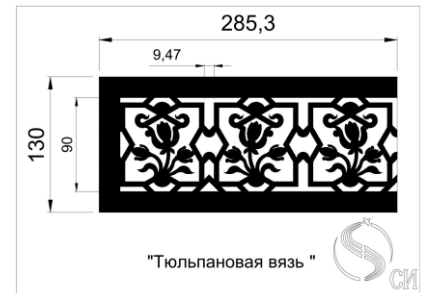
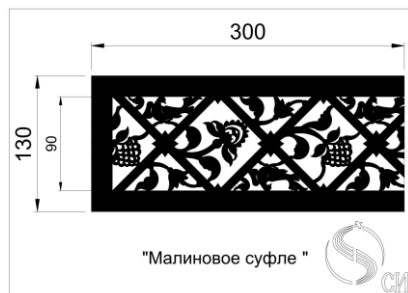
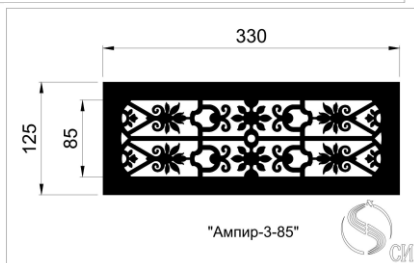
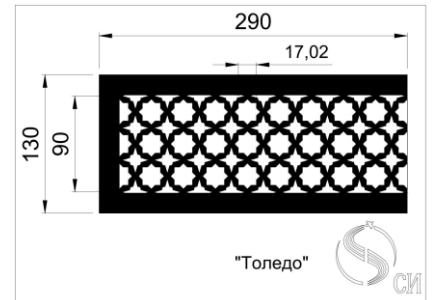
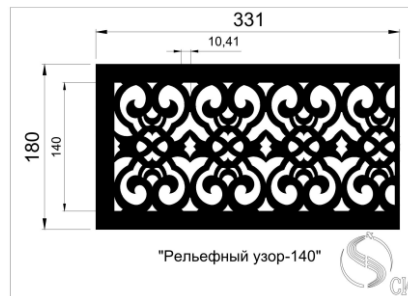
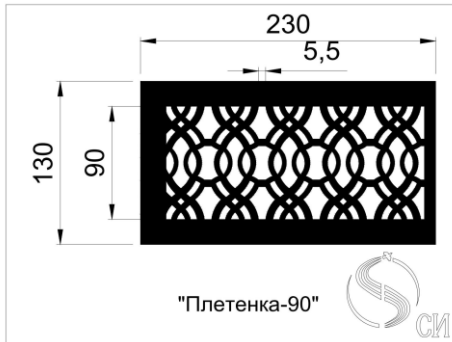
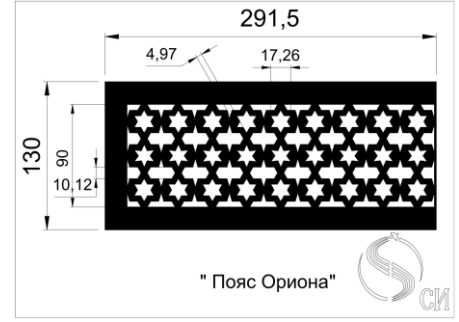
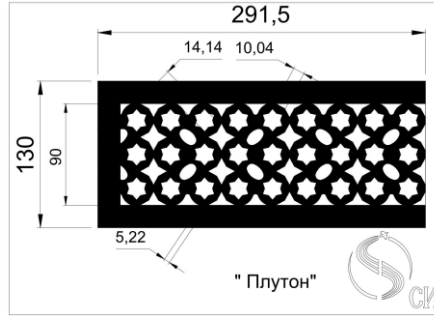
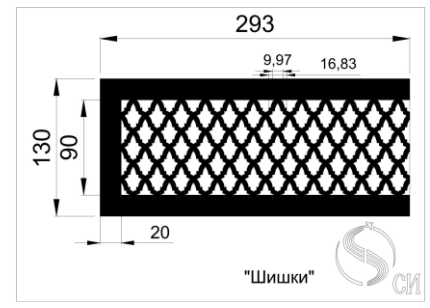
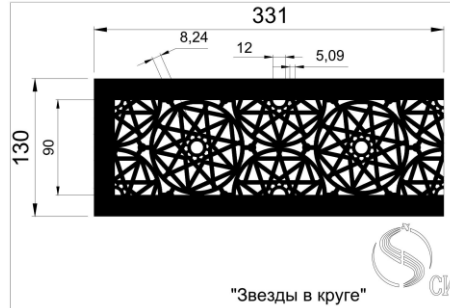
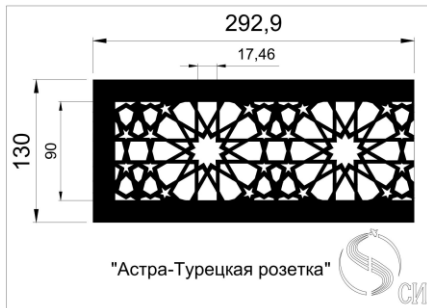

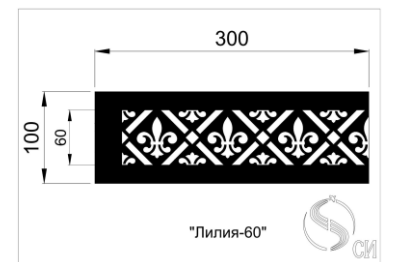
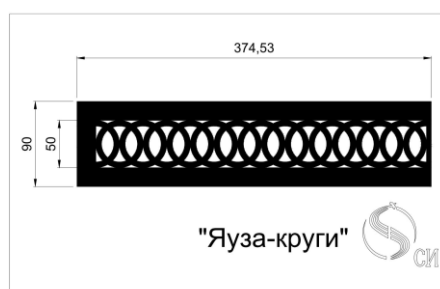
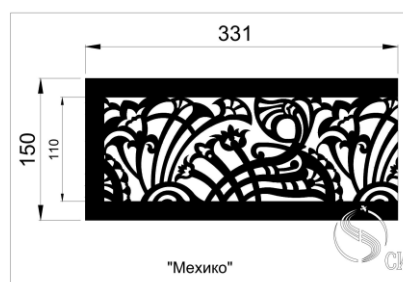
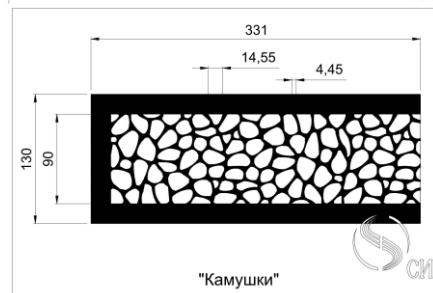
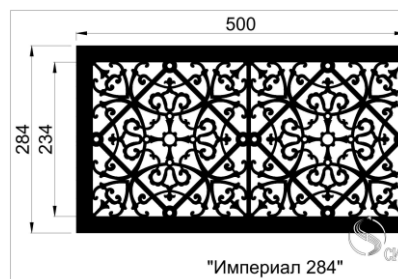
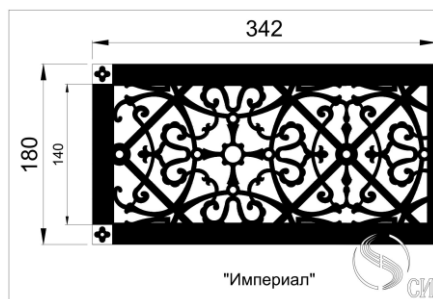
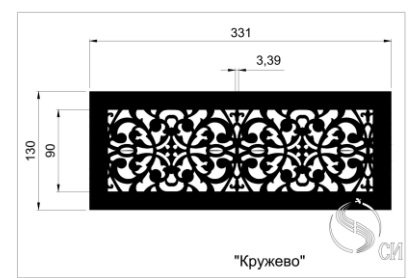
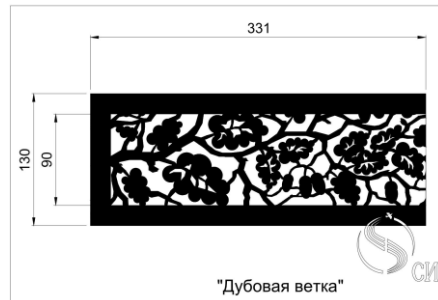
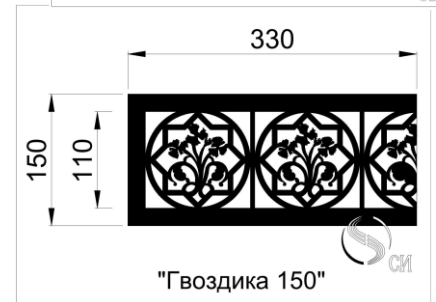
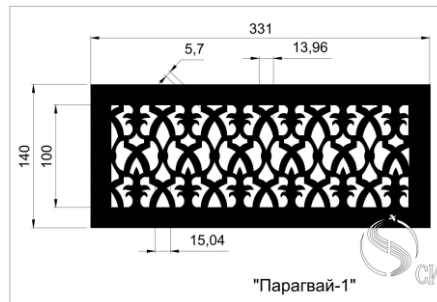
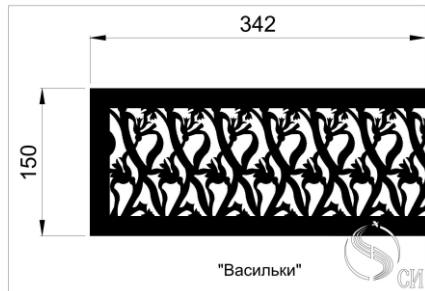
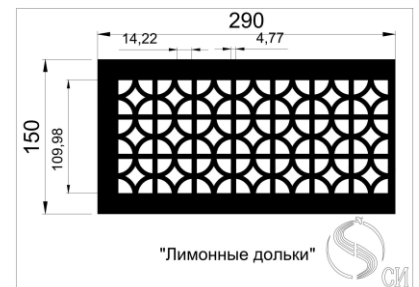
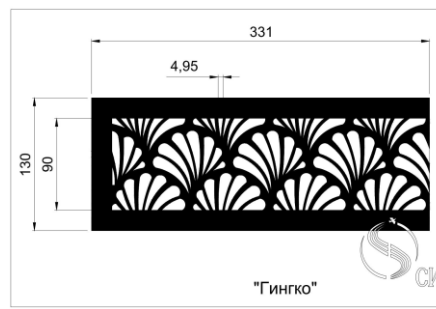
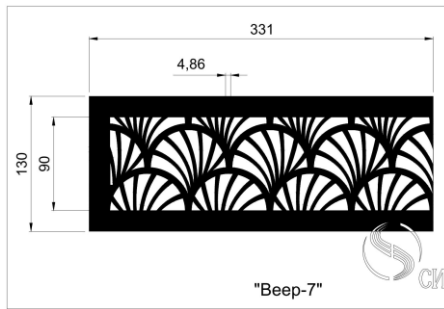

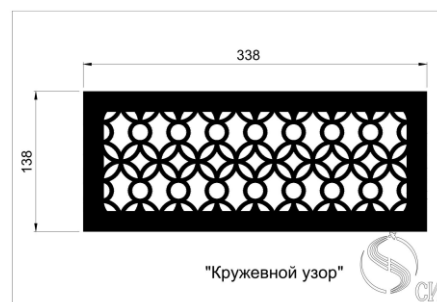
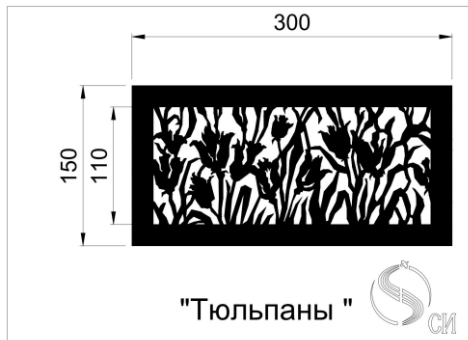
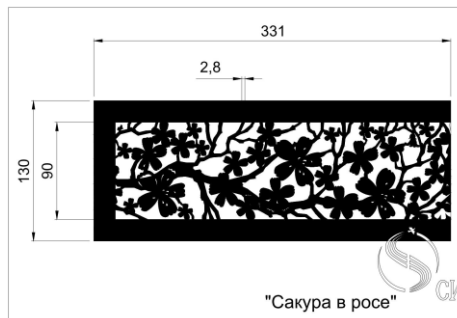
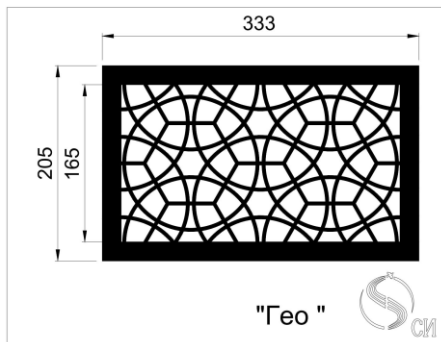
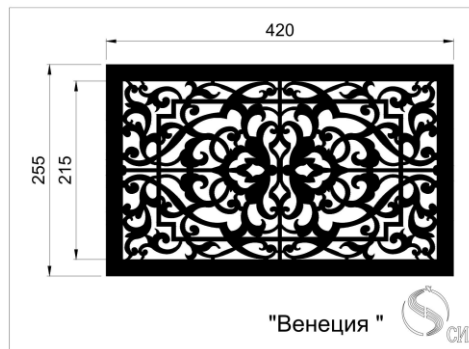
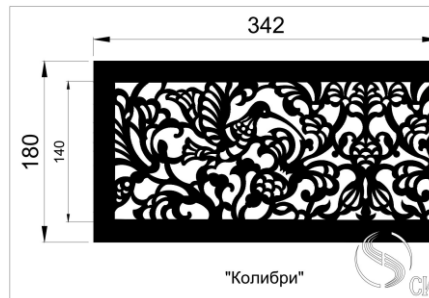
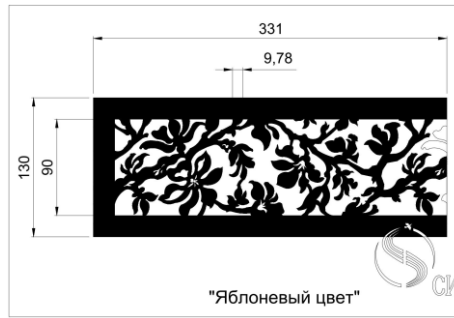



КАТАЛОГ узоров Деко для решеток дымоудаления

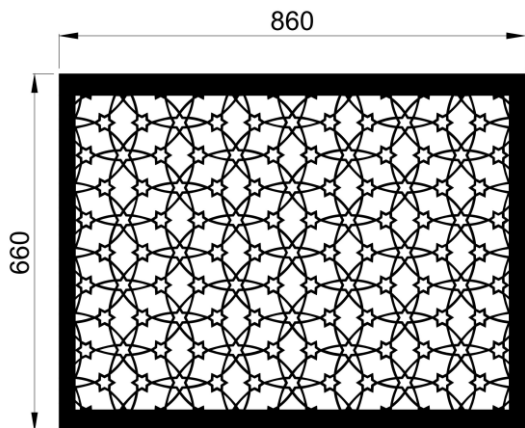

К.ж.с.=0,82

"Галактика"

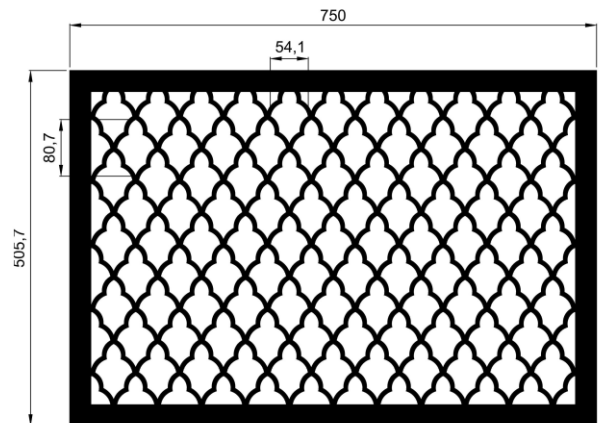

"Классик"

К.ж.с.=0,81

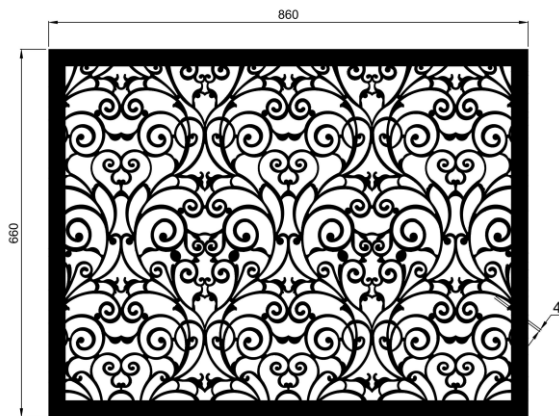

"Растительный узор" К.ж.с.=0,8

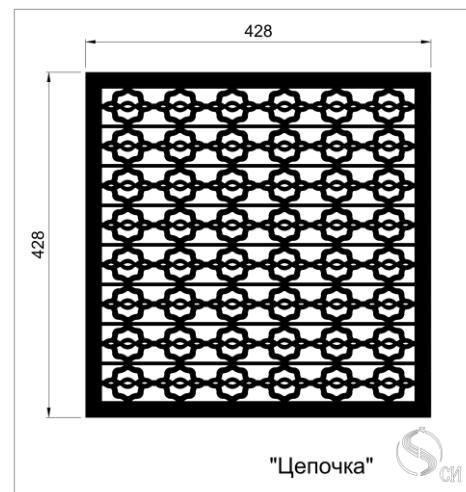

"Цепочка"

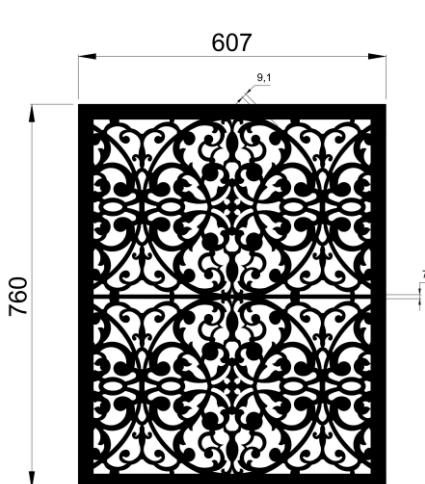

Кружево 1

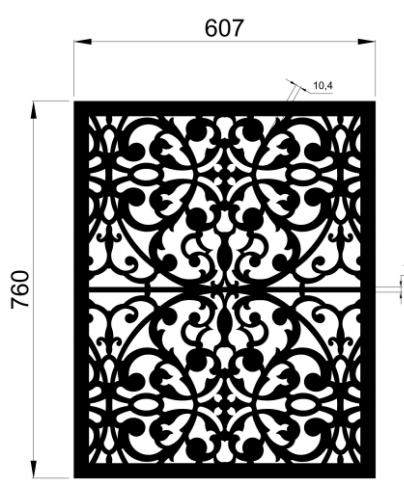

Кружево 2

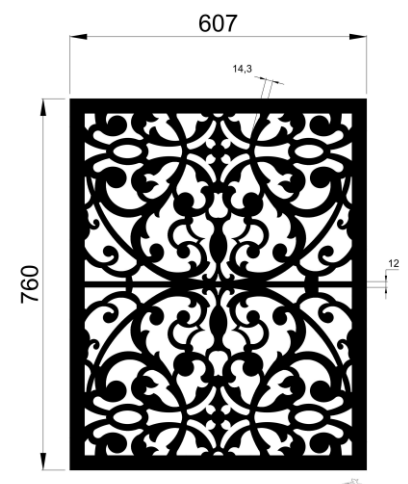

Кружево 3

Декоративные узоры для решеток могут использоваться специально для решеток дымоудаления и отвечают необходимым всем требованиям. Живое сечение в таких решетках составляет от 0,8 до 0,86 К.ж.с.

Решетки изготавливаются из стали 1(1,5-2)мм и окрашиваются порошковой эмалью при температуре 200



КАТАЛОГ узоров Деко для решеток дымоудаления

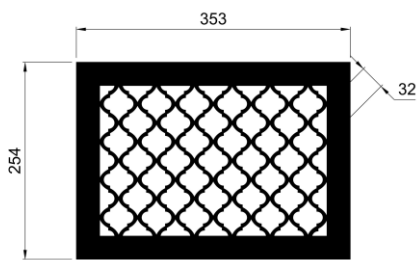

Боярская
вязь

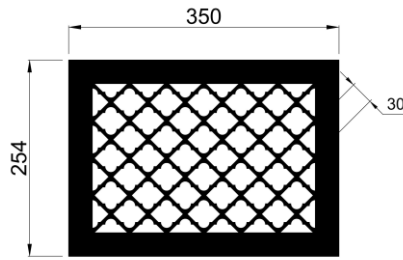

Крекер

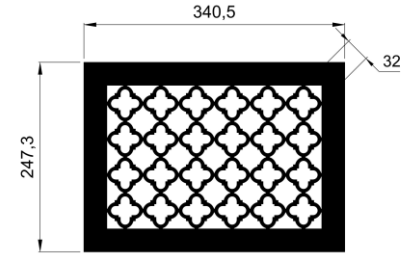

Купеческая
вязь

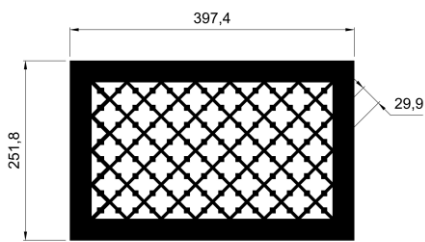

Крестоцвет

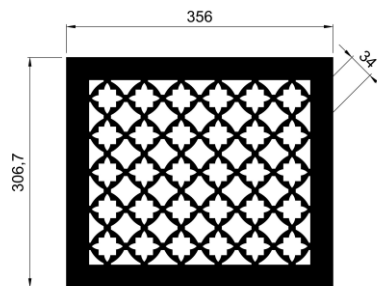

Вечерние
огни

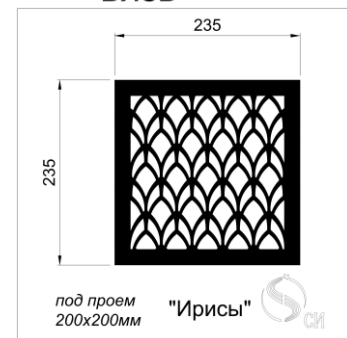

"Ирисы"

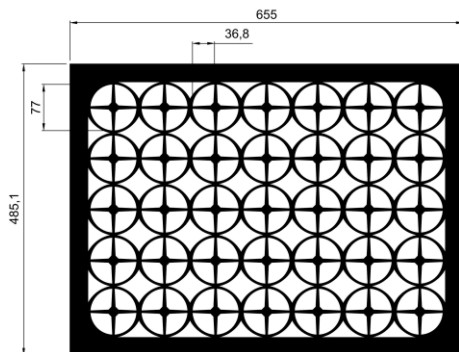

Апельсиновые
дольки

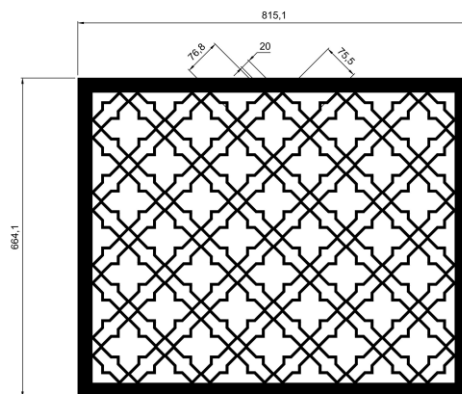

Византия

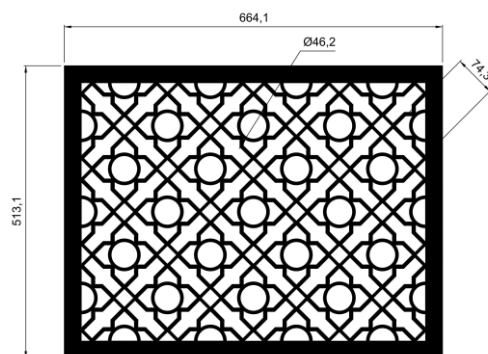

Дели -1

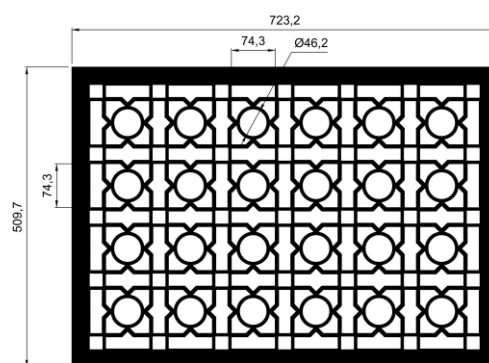

Дели-2



Геометрические и декоративные узоры для решеток могут использоваться специально для решеток дымоудаления и отвечают необходимым всем требованиям. Живое сечение в таких решетках составляет от 0,8 до 0,86 К.ж.с.

Решетки изготавливаются из стали 1(1,5-2)мм и окрашиваются порошковой эмалью при температуре 200



КАТАЛОГ узоров Деко для решеток дымоудаления

Решетки Деко -ДМУ представляют собой эстетичные панели, с геометрическим узором, который режется лазером. Их легко можно подобрать для потолков и стен. Они легко впишутся в интерьер создавая легкость и красоту.

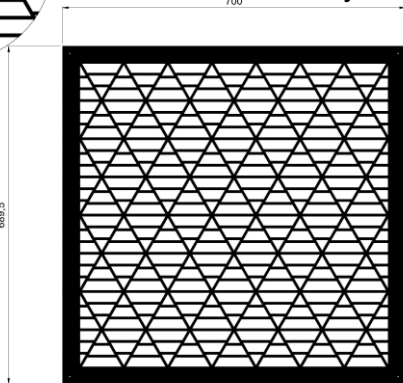
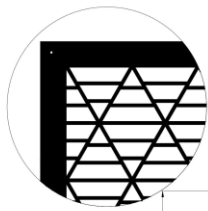

Узор 31

 **Узор 31**

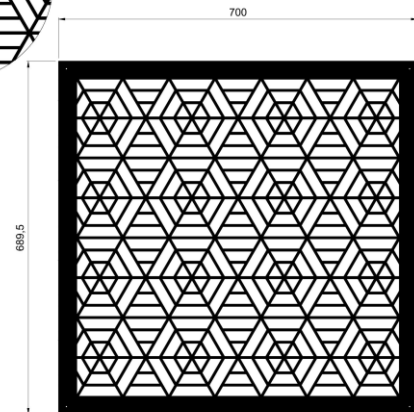
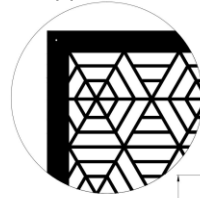

Узор 32

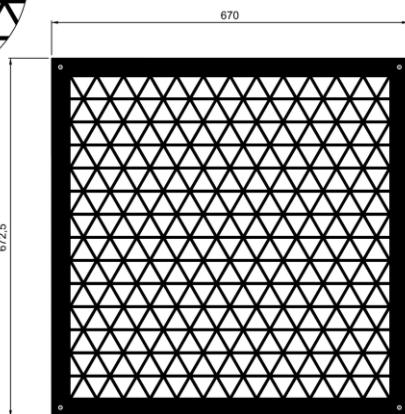
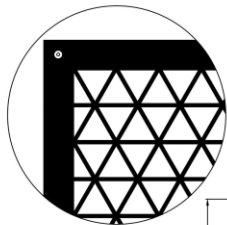

Узор 33

 **Узор 33**

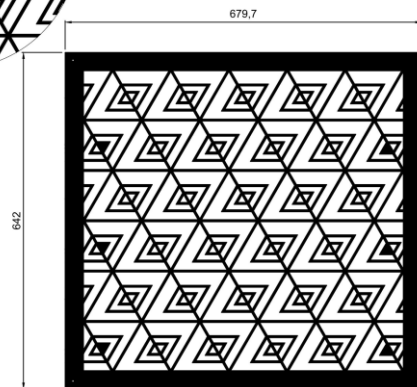
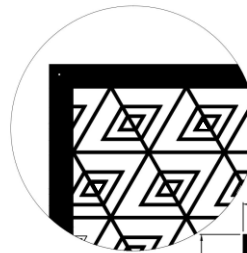

Узор 34



Узор 32

Узор 34

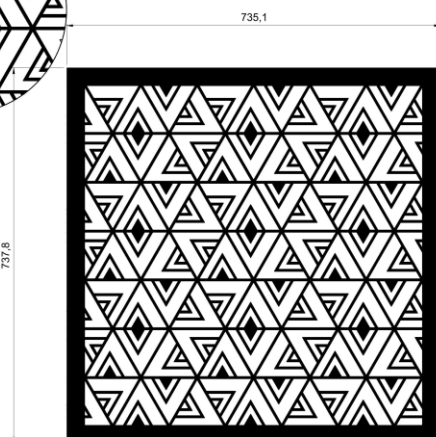

Узор 35

 **Узор 35**

Геометрические узоры для решеток созданы специально для решеток дымоудаления и отвечают всем требованиям. Живое сечение в таких решетках составляет от 0,8 до 0,86 К.ж.с. Решетки изготавливаются из стали 1(1,5-2)мм и окрашиваются порошковой эмалью при температуре 200 градусов